



07/sep to 20 sep 2018

SR NO	NAME OF STUDENT	DATE	1 07/09	2 8/09	3 8/09	4 10/9	5 10/9	6 11/9	7 11/9	8 17/9	9 17/9	10 19/9	11 19/9	12 20/9
1	ATOLE BHAGYASHREE BABASAHEB		Atole	Atole	Atole	Atole	Atole	Atole	Atole	Atole	Atole	Atole	Atole	Atole
2	BADE NIKHIL LALAJI		Nbade	Nbade	Nbade	Nbade	Nbade	Nbade	Nbade	Nbade	Nbade	Nbade	Nbade	Nbade
3	BHAGAT HARSHVARDHAN RAJENDRA		Hb.	Hb	Hb	Hb	Hb	Hb	Hb	Hb	Hb	Hb	Hb	Hb
4	BHOITE RHISHIKESH TANAJI		Rbhoite	Rbhoite	Rbhoite	Rbhoite	Rbhoite	Rbhoite	Rbhoite	Rbhoite	Rbhoite	Rbhoite	Rbhoite	Rbhoite
5	BHOSALE SHUBHAM SUNIL		Sbhosale	Sbhosale	Sbhosale	Sbhosale	Sbhosale	Sbhosale	Sbhosale	Sbhosale	Sbhosale	Sbhosale	Sbhosale	Sbhosale
6	BIDAVE SNEHAL KASHINATH		Sbidave	Sbidave	Sbidave	Sbidave	Sbidave	Sbidave	Sbidave	Sbidave	Sbidave	Sbidave	Sbidave	Sbidave
7	CHAURE KUNAL GOJIR		Cchaure	Cchaure	Cchaure	Cchaure	Cchaure	Cchaure	Cchaure	Cchaure	Cchaure	Cchaure	Cchaure	Cchaure
8	GAIKWAD ROHIT RAMDAS		Rgaikwad	Rgaikwad	Rgaikwad	Rgaikwad	Rgaikwad	Rgaikwad	Rgaikwad	Rgaikwad	Rgaikwad	Rgaikwad	Rgaikwad	Rgaikwad
9	GAIKWAD SHUBHAM NAGESH		Sgaikwad	Sgaikwad	Sgaikwad	Sgaikwad	Sgaikwad	Sgaikwad	Sgaikwad	Sgaikwad	Sgaikwad	Sgaikwad	Sgaikwad	Sgaikwad
10	GAIKWAD SWARAJ SADANAND		Sgaikwad	Sgaikwad	Sgaikwad	Sgaikwad	Sgaikwad	Sgaikwad	Sgaikwad	Sgaikwad	Sgaikwad	Sgaikwad	Sgaikwad	Sgaikwad
11	GAIKWAD VISHVAJEET BALAJIRAO		Vgaikwad	Vgaikwad	Vgaikwad	Vgaikwad	Vgaikwad	Vgaikwad	Vgaikwad	Vgaikwad	Vgaikwad	Vgaikwad	Vgaikwad	Vgaikwad
12	GHANERI SHIVAM SUNIL		Sghaneri	Sghaneri	Sghaneri	Sghaneri	Sghaneri	Sghaneri	Sghaneri	Sghaneri	Sghaneri	Sghaneri	Sghaneri	Sghaneri
13	GHARE AMAR PRAKASH		Aghare	Aghare	Aghare	Aghare	Aghare	Aghare	Aghare	Aghare	Aghare	Aghare	Aghare	Aghare
14	INGLE PRATHAMESH EKNATH		Pingle	Pingle	Pingle	Pingle	Pingle	Pingle	Pingle	Pingle	Pingle	Pingle	Pingle	Pingle
15	JADHAV RANJIT RAJARAM		Rjadhav	Rjadhav	Rjadhav	Rjadhav	Rjadhav	Rjadhav	Rjadhav	Rjadhav	Rjadhav	Rjadhav	Rjadhav	Rjadhav
16	KHILLARE SHUBHAM SADASHIV		Khillare	Khillare	Khillare	Khillare	Khillare	Khillare	Khillare	Khillare	Khillare	Khillare	Khillare	Khillare
17	KSHIRSAGAR SANJANA RAJENDRA		Sksirsagar	Sksirsagar	Sksirsagar	Sksirsagar	Sksirsagar	Sksirsagar	Sksirsagar	Sksirsagar	Sksirsagar	Sksirsagar	Sksirsagar	Sksirsagar
18	LABADE ROHAN HARIDAS		Rlabade	Rlabade	Rlabade	Rlabade	Rlabade	Rlabade	Rlabade	Rlabade	Rlabade	Rlabade	Rlabade	Rlabade
19	SHUBHAM KAMBLE		Skamble	Skamble	Skamble	Skamble	Skamble	Skamble	Skamble	Skamble	Skamble	Skamble	Skamble	Skamble
20	suryawanshi HARISHCHANDRA SHANKAR		Ssuryawanshi	Ssuryawanshi	Ssuryawanshi	Ssuryawanshi	Ssuryawanshi	Ssuryawanshi	Ssuryawanshi	Ssuryawanshi	Ssuryawanshi	Ssuryawanshi	Ssuryawanshi	Ssuryawanshi
21	RAUT MOHAN BHARAT		Rraut	Rraut	Rraut	Rraut	Rraut	Rraut	Rraut	Rraut	Rraut	Rraut	Rraut	Rraut
22	PATIL SACHIN BALA		Spatil	Spatil	Spatil	Spatil	Spatil	Spatil	Spatil	Spatil	Spatil	Spatil	Spatil	Spatil
23	KAMBLE YOGESH BHIKAJI		Ykamble	Ykamble	Ykamble	Ykamble	Ykamble	Ykamble	Ykamble	Ykamble	Ykamble	Ykamble	Ykamble	Ykamble
24	PANDHRE AKASH DHONDIRAM		Apandhre	Apandhre	Apandhre	Apandhre	Apandhre	Apandhre	Apandhre	Apandhre	Apandhre	Apandhre	Apandhre	Apandhre
25	SHIVSHRAN BHAKTI UTTAM		Ushivshran	Ushivshran	Ushivshran	Ushivshran	Ushivshran	Ushivshran	Ushivshran	Ushivshran	Ushivshran	Ushivshran	Ushivshran	Ushivshran
26	MIRGALE NANDINI ANANT		Nmirgale	Nmirgale	Nmirgale	Nmirgale	Nmirgale	Nmirgale	Nmirgale	Nmirgale	Nmirgale	Nmirgale	Nmirgale	Nmirgale
27	SHINDE OMKAR G		Oshinde	Oshinde	Oshinde	Oshinde	Oshinde	Oshinde	Oshinde	Oshinde	Oshinde	Oshinde	Oshinde	Oshinde
28	PATIL VISHAL VIJAYKUMAR		Vpatil	Vpatil	Vpatil	Vpatil	Vpatil	Vpatil	Vpatil	Vpatil	Vpatil	Vpatil	Vpatil	Vpatil
29	NARSAPURE ABHIJIT		Abnarsapure	Abnarsapure	Abnarsapure	Abnarsapure	Abnarsapure	Abnarsapure	Abnarsapure	Abnarsapure	Abnarsapure	Abnarsapure	Abnarsapure	Abnarsapure
30	MASHETTE AVINASH RAMESH		Amashette	Amashette	Amashette	Amashette	Amashette	Amashette	Amashette	Amashette	Amashette	Amashette	Amashette	Amashette

Soram Appanicut
(Faculty co-ordinator)



Head of the Department
CIVIL ENGINEERING
Genba Sopanrao Moze College of Engineering
25/10/18 Balewadi, Pune 411045

Certificate of Participation



This is to certify that **HARISHCHANDRA SHANKAR SURYAWANSHI**

has participated in **"Introduction to CAD"**

a complimentary training program conducted by

CADD Centre Training Services,
Aundh, Pune

During September 2018

Venue: Genba Sopanrao Moze College of Engineering, Balewadi-Baner, Pune

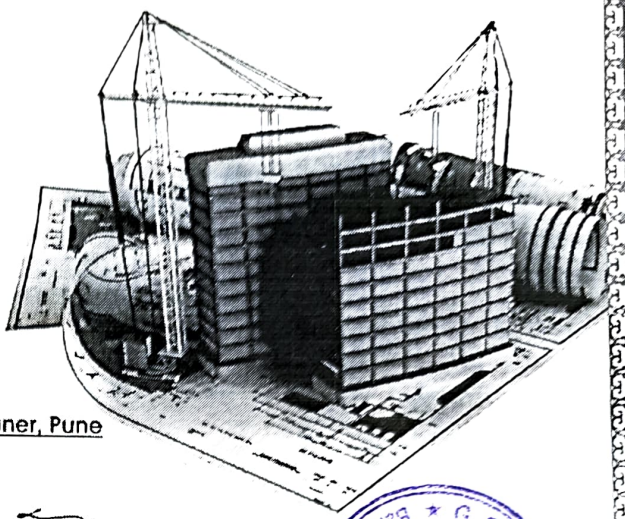

S. Karaiadiselvan - Managing Director



..... CADD Centre and CADD Centre logo are registered trademarks of CADD Centre Training Services Private Limited. All brand names and trademarks belong to respective owners.
A CSR initiative of CADD Centre
AUTODESK | cadence | ANSYS | Bentley | ORACLE | PTC | PHENOMAT
CADD Centre uses legal software from the above software developers. CADD Centre students are employed in many reputed companies and universities in several countries worldwide
www.caddcentre.com

Certificate of Participation



Certificate of Participation



This is to certify that **SHUBHAM KHILLARE**

has participated in **"Introduction to CAD"**

a complimentary training program conducted by

**CADD Centre Training Services,
Aundh, Pune**

During September 2018

Venue: Genba Sopanrao Moze College of Engineering, Balewadi-Baner, Pune

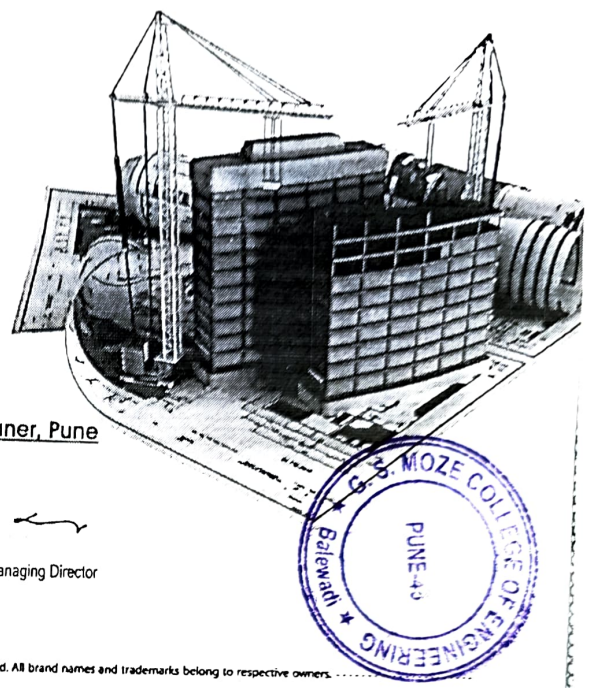

S. Karaiadiselman - Managing Director

..... CADD Centre and CADD Centre logo are registered trademarks of CADD Centre Training Services Private Limited. All brand names and trademarks belong to respective owners.
A CSR Initiative of CADD Centre
 | | | | | | |
CADD Centre uses legal software from the above software developers. CADD Centre students are employed in many reputed companies and universities in several countries worldwide.
www.caddcentre.com

Certificate of Participation



This is to certify that **SWARAJ SADANAND GAIKWAD**

has participated in **"Introduction to CAD"**

a complimentary training program conducted by

**CADD Centre Training Services,
Aundh, Pune**

During September 2018

Venue: Genba Sopanrao Moze College of Engineering, Balewadi-Baner, Pune

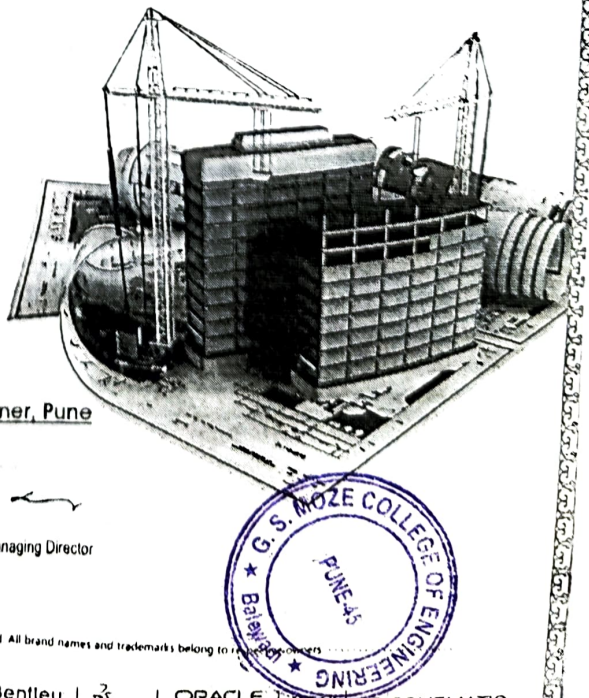

S. Karaiadiselman - Managing Director

..... CADD Centre and CADD Centre logo are registered trademarks of CADD Centre Training Services Private Limited. All brand names and trademarks belong to respective owners.
A CSR Initiative of CADD Centre
 | | | | | | |
CADD Centre uses legal software from the above software developers. CADD Centre students are employed in many reputed companies and universities in several countries worldwide.
www.caddcentre.com

Certificate of Participation



This is to certify that **RHISHIKESH BHOITE**

has participated in **"Introduction to CAD"**

a complimentary training program conducted by

**CADD Centre Training Services,
Aundh, Pune**

During September 2018

Venue: Genba Sopanrao Moze College of Engineering, Balewadi-Baner, Pune

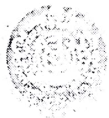
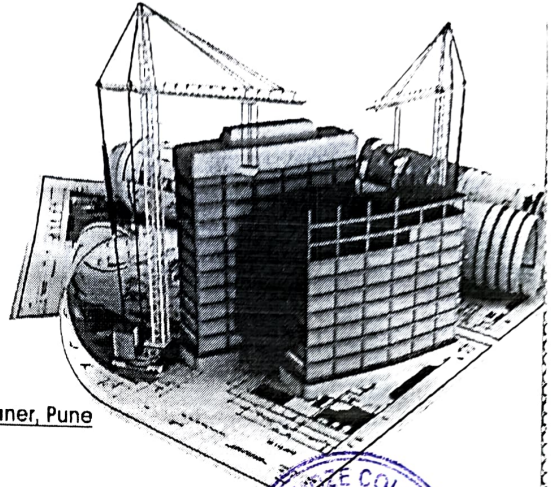

[Signature]

S. Karaiadiselvan - Managing Director



----- CADD Centre and CADD Centre logo are registered trademarks of CADD Centre Training Services Private Limited. All brand names and trademarks belong to respective owners. -----

A CSR Initiative of CADD Centre

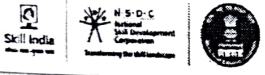

AUTODESK. | cadence | ANSYS | Bentley | SolidWorks | ORACLE | PTC | PC SCHEMATIC
PRIMAVERA

CADD Centre uses legal software from the above software developers. CADD Centre students are employed in many reputed companies and universities in several countries worldwide. www.caddcentre.com

Certificate of Participation



This is to certify that **GAIKWAD ROHIT RAMDAS**

has participated in **"Introduction to CAD"**

a complimentary training program conducted by

**CADD Centre Training Services,
Aundh, Pune**

During September 2018

Venue: Genba Sopanrao Moze College of Engineering, Balewadi-Baner, Pune

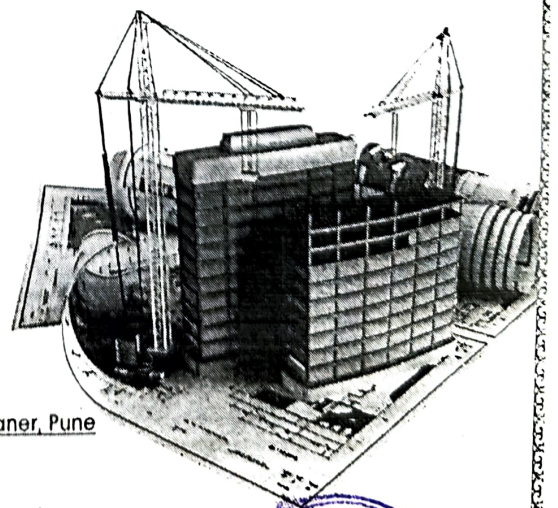

[Signature]

S. Karaiadiselvan - Managing Director



----- CADD Centre and CADD Centre logo are registered trademarks of CADD Centre Training Services Private Limited. All brand names and trademarks belong to respective owners. -----

A CSR Initiative of CADD Centre



AUTODESK. | cadence | ANSYS | Bentley | SolidWorks | ORACLE | PTC | PC SCHEMATIC
PRIMAVERA

CADD Centre uses legal software from the above software developers. CADD Centre students are employed in many reputed companies and universities in several countries worldwide. www.caddcentre.com



“EMPOWERMENT THROUGH TECHNOLOGICAL EXCELLENCE”
GENBA SOPANRAO MOZE COLLEGE OF ENGINEERING

S. No. 25/1/3, Balewadi-Baner, Pune- 411 045

(Approved by AICTE and Govt. of Maharashtra, Affiliated to Savitribai Phule Pune University)

DTE Code - EN6144 University Affiliation ID - PU/PN/ENGG/138/1999

Ph: 020-29513395

Website: www.gsmozecoe.co.in

Email: gsmoze@yahoo.co.in

Founder President: Shri. Rambhau Moze

Department of Computer Engineering
Spoken Tutorial Online Java Course

Attendance

A.Y.18-19

Sr.No	Student Name	12/1/201	19/01/201	2/2/201	9/2/201	16/09/201
.		9	9	9	9	9
1	ANUJA NARAYAN AROTE	P	P	P	P	P
2	SNEHALSUKHDEV AUTI	P	P	P	P	A
3	HARSHADA SHIVAJI BADGUJAR	P	P	P	P	P
4	SIDDHI CHANDRAKANT BOKIL	P	A	P	P	P
5	PRASAD RAMCHANDRA DHAKNE	P	P	P	P	P
6	AISHWARYA VIJAY FULPAGARE	P	P	P	P	P
7	CHAITNYA GOAPL GADALE	P	P	P	A	P
8	TEJASHREE GIRIDHAR GAJESHWAR	A	P	P	P	P
9	ATHARVA JITENDRA HUDE	P	P	P	P	P
10	VIKAS PRAKASH JADHAV	P	P	A	P	A
11	TRUPTI VINAYAK JAMDADE	P	P	P	P	P
12	ANIKET SATISH KASALE	P	A	P	P	P
13	OMKAR AVINASH MAHAJAN	P	P	P	P	P
14	SANKET JAGANNATH MORE	P	P	P	A	P
15	SMITAL RAJENDRA MORE	P	P	P	P	P
16	PRAKASH NARAYAN NAIKWADI	P	P	P	P	P
17	MANALI SANJAY NARKHEDE	P	P	P	P	P
18	LAXMAN MAHADU NEMANE	P	A	P	P	P
	LAXMAN ASHOK PACHE	P	P	P	A	P
20	SIDDHI SURESH PANCHAL	P	P	P	P	P

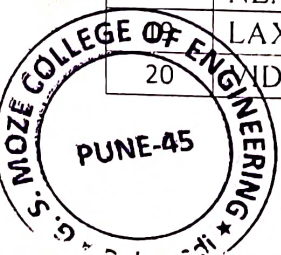



“EMPOWERMENT THROUGH TECHNOLOGICAL EXCELLENCE”

GENBA SOPANRAO MOZE COLLEGE OF ENGINEERING

S. No. 25/1/3, Balewadi-Baner, Pune- 411 045

Approved by AICTE and Govt. of Maharashtra, Affiliated to SavitribaiPhule Pune University)

DTE Code - EN6144 University Affiliation ID - PU/PN/ENGG/138/1999

Ph: 020-29513395 Website: www.gsmozecoe.co.in Email: gsmoze@yahoo.co.in

Founder President: Shri. RambhauMoze

21	SANDESH UTTAMRAO PARBHANKAR	P	P	P	P	P
22	SUSHMITA SANJAY PATIL	P	A	P	P	P
23	RUSHIKESH SURYAWANSHI	P	P	P	P	P
24	HITESH SURESH PATIL	P	P	P	A	P
25	ROHIT SUDAM PATIL	P	P	P	P	P
26	SINGH PRIYANKA BABLU	P	P	P	P	P
27	SOLIM DIKSHA DILIP	P	P	P	P	P
28	SONTAKKE SURAJ NAGNATH	P	A	P	P	P
29	SUNIL APPARAO GAIKWAD	P	P	P	A	P
30	SURWASE DIVYA DIGAMBER	P	P	P	P	P
31	SURYAWANSHI RUSHIKESH MOTIRAM	P	P	P	P	P
32	TAKALKAR PAYAL MADHUKAR	P	A	P	P	P
33	THOKE KAJAL BHIMSING	P	P	P	A	P
34	TOGGI VISHAKHA VIJAY	P	P	P	P	P
35	TULE NILAM SANTOSH	P	P	P	P	P
36	VEDPATHAK SAYALI NARAYANRAO	P	A	P	P	P
37	VIBHUTE SHREYAS SUNIL	P	P	P	A	P
38	WADKAR ATHARVA SANJAY	P	P	P	P	P
39	WAGH SWETA SUDHIR	P	P	P	P	P
40	WAGHMARE SAMRUDDHI MARUTI	P	P	P	A	P

Spoken Tutorial coordinator

HOD, COMP
Head of Department
COMPUTER ENGG.

Genba Sopanrao Moze College of Engg
25/1/3 Balewadi Pune-411 045

Principal

PRINCIPAL

Genba Sopanrao Moze College of Engg
25/1/3, Balewadi, Pune - 411 045





Spoken Tutorial

Certificate for Completion of Java Training



Talk To A Teacher

This is to certify that **ROHIT PATIL** has successfully completed Java test organized at **Genba Sopanrao Moze College of Engineering** by **Shital Kolte** with course material provided by the Talk To A Teacher project at IIT Bombay.

Passing an online exam, conducted remotely from IIT Bombay, is a pre-requisite for completing this training. **SNEHA FARKADE** at **Genba Sopanrao Moze College of Engineering** invigilated this examination. This training is offered by the **Spoken Tutorial Project, IIT Bombay**, funded by **National Mission on Education through ICT, MHRD, Govt., of India.**

February 22nd, 2019

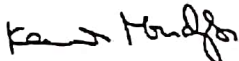
Prof. Kannan M Moudgalya
IIT Bombay

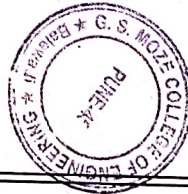

16925342D6



Certificate for Completion of Java Training



This is to certify that **HITESH PATIL** has successfully completed Java test organized at **Genba Sopanrao Moze College of Engineering** by **Shital Kolte** with course material provided by the Talk To A Teacher project at IIT Bombay.

Passing an online exam, conducted remotely from IIT Bombay, is a pre-requisite for completing this training. **SNEHA FARKADE** at **Genba Sopanrao Moze College of Engineering** invigilated this examination. This training is offered by the **Spoken Tutorial Project, IIT Bombay**, funded by **National Mission on Education through ICT, MHRD, Govt., of India**.

February 22nd, 2019

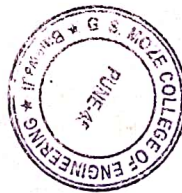

Kannan M Moudgalya
Prof. Kannan M Moudgalya
IIT Bombay



Certificate for Completion of Java Training



This is to certify that **RUSHIKESH S.** has successfully completed Java test organized at **Genba Sopanrao Moze College of Engineering** by **Shital Kolte** with course material provided by the Talk To A Teacher project at IIT Bombay.

Passing an online exam, conducted remotely from IIT Bombay, is a pre-requisite for completing this training. **SNEHA FARKADE** at **Genba Sopanrao Moze College of Engineering** invigilated this examination. This training is offered by the **Spoken Tutorial Project, IIT Bombay**, funded by **National Mission on Education through ICT, MHRD, Govt., of India.**

February 22nd, 2019

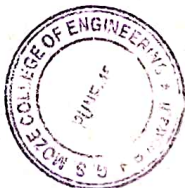

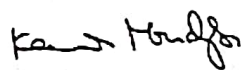
Prof. Kannan M Moudgalya
IIT Bombay



Spoken Tutorial

Certificate for Completion of Java Training



Talk To A Teacher

This is to certify that **SUSHMITA PATIL** has successfully completed Java test organized at **Genba Sopanrao Moze College of Engineering** by **Shital Kolte** with course material provided by the Talk To A Teacher project at IIT Bombay.

Passing an online exam, conducted remotely from IIT Bombay, is a pre-requisite for completing this training. **SNEHA FARKADE** at **Genba Sopanrao Moze College of Engineering** invigilated this examination. This training is offered by the **Spoken Tutorial Project, IIT Bombay**, funded by **National Mission on Education through ICT, MHRD, Govt., of India.**

February 22nd, 2019



Kannan M Moudgalya
Prof. Kannan M Moudgalya
IIT Bombay



Spoken Tutorial

Certificate for Completion of Java Training



Talk To A Teacher

This is to certify that **SANDESH P.** has successfully completed Java test organized at **Genba Sopanrao Moze College of Engineering** by **Shital Kolte** with course material provided by the Talk To A Teacher project at IIT Bombay.

Passing an online exam, conducted remotely from IIT Bombay, is a pre-requisite for completing this training. **SNEHA FARKADE** at **Genba Sopanrao Moze College of Engineering** invigilated this examination. This training is offered by the **Spoken Tutorial Project, IIT Bombay**, funded by **National Mission on Education through ICT, MHRD, Govt., of India.**

February 22nd, 2019

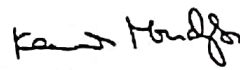

Prof. Kannan M Moudgalya
IIT Bombay



"EMPOWERMENT THROUGH TECHNOLOGICAL EXCELLENCE"

GENBA SOPANRAO MOZE COLLEGE OF ENGINEERING

S. No. 25/1/3, Balewadi-Baner, Pune- 411 045

Approved by AICTE and Govt. of Maharashtra, Affiliated to SavitribaiPhule Pune University)

DTE Code - EN6144 University Affiliation ID - PU/PN/ENGG/138/1999

Ph: 020-29513395 Website: www.gsmozecoe.co.in Email: gsmoze@yahoo.co.in

Founder President: Shri. RambhauMoze

Department of Information Technology

Academic Year 2018-19

Attendance for SPOKEN Tutorial

Course Name: C Language

Sr. No.	Name of the Student	01/07	02/07	03/07	08/07	09/07	10/07	15/07	16/7	17/7	17/7
1	Iyer Praharshita	P	P	P	P	A	P	P	P	P	P
p	Gomes Fransisco	P	A	P	P	p	P	P	P	P	P
3	Nimase Snehal	P	P	A	P	p	P	P	P	P	A

Spoken Tutorial Coordinator

Prof. Priyanka Mane

HOD IT

Prof. Priyanka More

Principal

Dr. A.B. Auti



Head of Department
Information Technology
Genba Sopanrao Moze College of Engg.
25/1/3, Balewadi, Pune-411 045.

PRINCIPAL

Genba Sopanrao Moze College of Engg
25/1/3, Balewadi, PUNE-411 045



Certificate for Completion of C Training



This is to certify that **PRAHARSHITA IYER** has successfully completed **C** test organized at **Genba Sopanrao Moze College of Engineering** by **Priyanka Mane** with course material provided by the Talk To A Teacher project at IIT Bombay.

Passing an online exam, conducted remotely from IIT Bombay, is a pre-requisite for completing this training. **Pranali Deshmukh** at **Genba Sopanrao Moze College of Engineering** invigilated this examination. This training is offered by the **Spoken Tutorial Project, IIT Bombay, funded by National Mission on Education through ICT, MHRD, Govt., of India.**

JULY 20th 2018

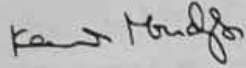

Prof. Kannan M Moudgalya
IIT Bombay



Certificate for Completion of C++ Training



This is to certify that **FRANCISCO GOMES** has successfully completed C++ test organized at **Genba Sopanrao Moze College of Engineering** by **Priyanka Mane** with course material provided by the Talk To A Teacher project at IIT Bombay.

Passing an online exam, conducted remotely from IIT Bombay, is a pre-requisite for completing this training. **Pranali Deshmukh** at **Genba Sopanrao Moze College of Engineering** invigilated this examination. This training is offered by the **Spoken Tutorial Project, IIT Bombay, funded by National Mission on Education through ICT, MHRD, Govt., of India.**

JULY 20th 2018

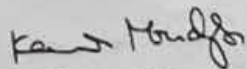
Prof. Kannan M Moudgalya
IIT Bombay



Certificate for Completion of C Training



This is to certify that **NEHA RAWANDALEKAR** has successfully completed **C** test organized at **Genba Sopanrao Moze College of Engineering** by **Priyanka Mane** with course material provided by the Talk To A Teacher project at IIT Bombay.

Passing an online exam, conducted remotely from IIT Bombay, is a pre-requisite for completing this training. **Pranali Deshmukh** at **Genba Sopanrao Moze College of Engineering** invigilated this examination. This training is offered by the **Spoken Tutorial Project, IIT Bombay, funded by National Mission on Education through ICT, MHRD, Govt., of India.**

JULY 20th 2018

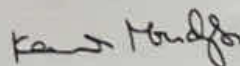

Prof. Kannan M Moudgalya
IIT Bombay



Genba Sopanrao Moze Trust's
GENBA SOPANRAO MOZE COLLEGE OF ENGINEERING
 Balewadi, Pune-411045
 Department of Mechanical Engineering
 Academic Year-2018-19

Softskill (HYPERMESH) Training by Mr. Sushilkumar Bhagat (G2G Innovation)

Roll No	Name	Attendance (3/9/2018)	Attendance (4/9/2018)	Attendance (5/9/2018)	Attendance (6/9/2018)	Attendance (7/9/2018)	Attendance (8/9/2018)
1	SANDESH NAVALE	Sandesh	Sandesh	Sandesh	Sandesh	Sandesh	Sandesh
2	AMAR KHILLARE	Amar	-AB-	Amar	Amar	Amar	Amar
3	RAHUL CHILEKAR	B.	B	B	B	B	B
4	SAYYAD ASH	Ash	Ash	Ash	Ash	Ash	Ash
5	SHIVAM GONDKAR	Sus	Sus	Sus	-AB-	Sus	Sus
6	SATYAM GONDKAR	Cus	Cus	Cus	Cus	Cus	Cus
7	ATUL HIRALKAR	Atul	Atul	Atul	Atul	Atul	Atul
8	SANATAN AMBULKAR	As	As	As	As	-AB-	As
9	YOGESH CHAVAN	A	A	A	A	A	A
10	NIKHIL DESHMUKH	Nikhil	Nikhil	Nikhil	Nikhil	Nikhil	Nikhil
11	UMESH DANDGE	Dandge	Dandge	-AB	Dandge	Dandge	Dandge
12	ROHAN PACHARNE	Rohan	Rohan	Rohan	Rohan	Rohan	Rohan
13	AMARJEET THITE	Amar	Amar	Amar	Amar	Amar	Amar
14	AMIR ANSARI	ansari	ansari	ansari	ansari	ansari	ansari
15	RAJDEEP SHINDE	Shinde	Shinde	-AB	Shinde	Shinde	Shinde
16	VISHNUDAS DONGRE	VD	VD	VD	VD	VD	VD
17	PRAFFUL SATHONE	Sathone	Sathone	Sathone	Sathone	Sathone	Sathone
18	KALYANI SONAWANE	(K)	-AB-	(K)	(K)	(K)	(K)
19	PRAMOD INGOLE	Pramad	Pramad	Pramad	Pramad	Pramad	Pramad
20	ANIL S INGLE	Anil	Anil	Anil	Anil	Anil	Anil
21	DHANRAJ SHINDE	shinde	shinde	shinde	shinde	-AB	shinde
22	AKSHAY VITNOR	Vitnor	Vitnor	Vitnor	Vitnor	Vitnor	Vitnor
23	AKASH SUTAR	Sutar	Sutar	Sutar	-AB-	Sutar	Sutar
24	ADITYA JANUNKAR	-AB-	Aditya	Aditya	Aditya	Aditya	Aditya
25	ANIL G INGLE	Ingle	Ingle	Ingle	Ingle	Ingle	Ingle

Handwritten signature and notes at the bottom left of the page.

Head of the Department,
MECHANICAL ENGINEERING
 Genba Sopanrao Moze College of Engg.
 25/1/3, Balewadi, Pune-411045

Genba Sopanrao Moze Trust's
GENBA SOPANRAO MOZE COLLEGE OF ENGINEERING
 Balewadi, Pune-411045
 Department of Mechanical Engineering
 Academic Year-2018-19

Softskill (HYPERMESH) Training by Mr. Sushilkumar Bhagat (G2G Innovation)

Roll No	Name	Attendance (10/9/2018)	Attendance (11/9/2018)	Attendance (12/9/2018)	Attendance (13/9/2018)	Attendance (14/9/2018)	Attendance (15/9/2018)
1	SANDESH NAVALI	Sandesh	Sandesh	Sandesh	Sandesh	Sandesh	Sandesh
2	AMAR KHILLARE	Amar	Amar	Amar	-AB-	Amar	Amar
3	RAHUL CHILEKAR	-AB-	B	B	B	B	B
4	SAYYAD ASIF	Asif	Asif	Asif	Asif	Asif	Asif
5	SHIVAM GONDKAR	Shivam	Shivam	Shivam	Shivam	Shivam	Shivam
6	SATYAM GONDKAR	Satyam	-AB-	Satyam	Satyam	Satyam	Satyam
7	ATUL HIRALKAR	Atul	Atul	Atul	Atul	Atul	Atul
8	SANATAN AMBULKAR	Sanatan	Sanatan	Sanatan	Sanatan	Sanatan	Sanatan
9	YOGESH CHAVAN	Yogesh	Yogesh	-AB-	Yogesh	Yogesh	Yogesh
10	NIKHIL DESHMUKH	Nikhil	Nikhil	Nikhil	Nikhil	Nikhil	Nikhil
11	UMESH DANDGE	Dandge	Dandge	Dandge	Dandge	Dandge	Dandge
12	ROHAN PACHARNE	Rohan	Rohan	Rohan	Rohan	Rohan	Rohan
13	AMARJEET THITE	Amarjeet	Amarjeet	-AB-	Amarjeet	Amarjeet	Amarjeet
14	AMIR ANSARI	A	A	(A)	(A)	(A)	(A)
15	RAJDEEP SHINDE	Shinde	Shinde	Shinde	Shinde	Shinde	Shinde
16	VISHNUDAS DONGRE	VD	VD	VD	VD	VD	VD
17	PRAFFUL SATHONE	Sathone	Sathone	Sathone	Sathone	Sathone	Sathone
18	KALYANI SONAWANE	(K)	(K)	(K)	(K)	(K)	(K)
19	PRAMOD INGOLE	Pramod	Pramod	Pramod	-AB-	Pramod	Pramod
20	ANIL S INGLE	Anil	Anil	Anil	Anil	Anil	Anil
21	DHANRAJ SHINDE	Shinde	Shinde	Shinde	Shinde	Shinde	Shinde
22	AKSHAY VITNOR	Vitnor	Vitnor	Vitnor	Vitnor	Vitnor	Vitnor
23	AKASH SUTAR	Seitar	Seitar	Seitar	-AB-	Seitar	Seitar
24	ADITYA JANUNKAR	Aditya	Aditya	Aditya	Aditya	Aditya	Aditya
25	ANIL G INGLE	Ingle	Ingle	Ingle	Ingle	Ingle	Ingle

Handwritten signature and text at the bottom left.

Head of the Department,
MECHANICAL ENGINEERING
 Genba Sopanrao Moze College of Engg.
 25/1/3, Balewadi, Pune-411 045.



Genba Sopanrao Moze Trust's
 GENBA SOPANRAO MOZE COLLEGE OF ENGINEERING
 Balewadi, Pune-411045
 Department of Mechanical Engineering
 Academic Year-2018-19

Softskill (HYPERMESH) Training by Mr. Sushilkumar Bhagat (G2G Innovation)

Roll No	Name	Attendance (17/9/2018)	Attendance (18/9/2018)	Attendance (19/9/2018)	Attendance (20/9/2018)	Attendance (21/9/2018)	Attendance (22/9/2018)
1	SANDESH NAVALE	Sandesh	Sandesh	Sandesh	Sandesh	Sandesh	Sandesh
2	AMAR KHILLARE	Amar	Amar	Amar	Amar	Amar	Amar
3	RAHUL CHILEKAR	P	-AG-	P	P	P	P
4	SAYYAD ASIF	Asif	Asif	Asif	Asif	Asif	Asif
5	SHIVAM GONDKAR	Surya	Surya	Surya	Surya	Surya	Surya
6	SATYAM GONDKAR	Amul	Amul	Amul	Amul	Amul	-AG-
7	ATUL HIRALKAR	Atul	Atul	Atul	Atul	Atul	Atul
8	SANATAN AMBULKAR	As	As	As	As	As	As
9	YOGESH CHAVAN	Yogesh	Yogesh	Yogesh	Yogesh	Yogesh	Yogesh
10	NIKHIL DESHMUKH	Nikhil	Nikhil	Nikhil	Nikhil	Nikhil	Nikhil
11	LIMESH DANDGE	Dandge	Dandge	Dandge	Dandge	Dandge	Dandge
12	ROHAN PACHARNE	Rohan	Rohan	Rohan	Rohan	Rohan	Rohan
13	AMARJEET THITE	Amar	Amar	Amar	Amar	Amar	Amar
14	AMER ANSARI	(A)	(A)	(A)	(A)	(A)	-AG-
15	RAJDEEP SHINDE	Shinde	-AG-	Shinde	Shinde	Shinde	Shinde
16	VISHNULIAS DONGRE	QAD	QAD	QAD	QAD	QAD	QAD
17	PRAFUL SATHONE	Sathone	Sathone	Sathone	Sathone	Sathone	Sathone
18	KALYANI SONAWANE	(K)	(K)	(K)	(K)	(K)	(K)
19	PRAMOD INGOLE	Pramod	Pramod	-AG-	Pramod	Pramod	Pramod
20	ANIL SINGLE	Anil	Anil	Anil	Anil	Anil	Anil
21	DHANRAJ SHINDE	Shinde	Shinde	Shinde	Shinde	Shinde	Shinde
22	AKSHAY VITNOR	Vitnor	Vitnor	Vitnor	Vitnor	Vitnor	Vitnor
23	AKASH SUTAR	Sutar	Sutar	Sutar	Sutar	Sutar	Sutar
24	ADITYA JANLINKAR	Aditya	Aditya	Aditya	-AG-	Aditya	Aditya
25	ANIL G INGLE	Ingle	Ingle	Ingle	Ingle	Ingle	Ingle

[Signature]
 P.P.P. S. S. Y. J. D. S.

MECHANICAL ENGINEERING

Genba Sopanrao Moze College of Engineering
 Balewadi, Pune-411045



Genba Sopanrao Moze Trust's
GENBA SOPANRAO MOZE COLLEGE OF ENGINEERING
 Balewadi, Pune-411045
 Department of Mechanical Engineering
 Academic Year-2018-19

Softskill (HYPERMESH) Training by Mr. Sushilkumar Bhagat (G2G Innovation)

Roll No	Name	Attendance (22/9/2018)	Attendance (24/9/2018)	Attendance (25/9/2018)	Attendance (26/9/2018)	Attendance (27/9/2018)	Attendance (28/9/2018)
1	SANDESH NAVALE	Sandesh	Sandesh	Sandesh	Sandesh	Sandesh	Sandesh
2	AMAR KHILLARE	Amar	Amar	Amar	Amar	Amar	Amar
3	RAHUL CHILEKAR	B	B	B	B	-AB-	B
4	SAYYAD ASIF	Asif	Asif	Asif	Asif	Asif	Asif
5	SHIVAM GONDKAR	Shivam	Shivam	Shivam	Shivam	Shivam	Shivam
6	SATYAM GONDKAR	-AB-	Cus	Cus	Cus	Cus	Cus
7	ATUL HIRALKAR	Atul	Atul	Atul	Atul	Atul	Atul
8	SANATAN AMBULKAR	As	As	As	As	As	As
9	YOGESH CHAVAN	Y	Y	Y	Y	Y	Y
10	NIKHIL DESHMUKH	Nikhil	Nikhil	Nikhil	Nikhil	Nikhil	Nikhil
11	UMESH DANDGE	Dandge	-AB-	Dandge	Dandge	Dandge	Dandge
12	ROHAN PACHARNE	Rohan	Rohan	Rohan	Rohan	Rohan	Rohan
13	AMARJEET THITE	Amar	Amar	Amar	Amar	Amar	Amar
14	AMIR ANSARI	A	A	A	A	A	A
15	RAJDEEP SHINDE	Shinde	Shinde	-AB-	Shinde	Shinde	Shinde
16	VISHNUDAS DONGRE	Vishnu	Vishnu	Vishnu	Vishnu	Vishnu	Vishnu
17	PRAFFUL SATHONE	Sathone	Sathone	Sathone	Sathone	Sathone	Sathone
18	KALYANI SONAWANE	R	R	R	R	R	R
19	PRAMOD INGOLE	Pramod	Pramod	Pramod	Pramod	Pramod	Pramod
20	ANIL SINGLE	Anil	Anil	Anil	Anil	Anil	Anil
21	DHANRAJ SHINDE	Shinde	Shinde	-AB-	Shinde	Shinde	Shinde
22	AKSHAY VITNOR	Vitnor	Vitnor	Vitnor	Vitnor	Vitnor	Vitnor
23	AKASH SUTAR	Sutar	Sutar	Sutar	Sutar	Sutar	Sutar
24	ADITYA JANUNKAR	Aditya	Aditya	Aditya	Aditya	Aditya	Aditya
25	ANIL G INGLE	Ingle	Ingle	Ingle	Ingle	Ingle	Ingle

Prof. S. S. Jadhav

Head of the Department,
MECHANICAL ENGINEERING
 Genba Sopanrao Moze College of Engg.
 25/1/3, Balewadi



Genba Sopanrao Moze Trust's
GENBA SOPANRAO MOZE COLLEGE OF ENGINEERING
 Balewadi, Pune-411045
 Department of Mechanical Engineering
 Academic Year-2018-19

Softskill (HYPERMESH) Training by Mr. Sushilkumar Bhagat (G2G Innovation)

Roll No	Name	Attendance 29/9/2018	Attendance (29/9/2018)	Attendance (01/10/2018)	Attendance (02/10/2018)	Attendance (03/10/2018)	Attendance (04/10/2018)
1	SANDESH NAVALE	Sandesh	Sandesh	Sandesh	Sandesh	Sandesh	Sandesh
2	AMAR KHILLARE	Amar	Amar	Amar	Amar	Amar	Amar
3	RAHUL CHILEKAR	R	B	-AB	B	R	B
4	SAYYAD ASIF	Asif	Asif	Asif	Asif	Asif	Asif
5	SHIVAM GONDKAR	Sush	Sush	Sush	Sush	Sush	Sush
6	SATYAM GONDKAR	Cus	Cus	Cus	Cus	Cus	Cus
7	ATUL HIRALKAR	Abul	Abul	Abul	-AB	Abul	Abul
8	SANATAN AMBULKAR	As	As	As	As	As	As
9	YOGESH CHAVAN	A	A	A	A	A	A
10	NIKHIL DESHMUKH	Nikhil	Nikhil	Nikhil	Nikhil	Nikhil	Nikhil
11	UMESH DANDGE	Dand	Dand	Dand	Dand	Dand	Dand
12	ROHAN PACHARNE	Rohan	-AB-	Rohan	Rohan	Rohan	Rohan
13	AMARJEET THITE	Aus	Aus	Aus	Aus	Aus	Aus
14	AMIR ANSARI	A	A	A	A	A	A
15	RAJDEEP SHINDE	Shinde	Shinde	Shinde	Shinde	Shinde	Shinde
16	VISHNUDAS DONGRE	VD	VD	VD	VD	VD	VD
17	PRAFFUL SATHONE	Sathone	Sathone	Sathone	Sathone	Sathone	Sathone
18	KALYANI SONAWANE	K	K	K	K	-AB-	K
19	PRAMOD INGOLE	Pramod	Pramod	Pramod	Pramod	Pramod	Pramod
20	ANIL S INGLE	Anil	Anil	Anil	Anil	Anil	Anil
21	DHANRAJ SHINDE	Shinde	Shinde	Shinde	Shinde	Shinde	Shinde
22	AKSHAY VITNOR	Vitnor	Vitnor	-AB-	Vitnor	Vitnor	Vitnor
23	AKASH SUTAR	Sutar	Sutar	Sutar	Sutar	Sutar	Sutar
24	ADITYA JANUNKAR	Aditya	Aditya	Aditya	Aditya	Aditya	Aditya
25	ANIL G INGLE	Ingle	Ingle	Ingle	Ingle	Ingle	-AB-

Prof. S. S. Jadhav

Head of the Department,
MECHANICAL ENGINEERING
 Genba Sopanrao Moze College of Engineering
 25/1/3, Balewadi, Pune 411 045



Softskill (CATIA) Training by Mr. Sushilkumar Bhagat (G2G Innovation)							
Roll No	Name	Attendance (1/3/2019)	Attendance (2/3/2019)	Attendance (4/3/2019)	Attendance (5/3/2019)	Attendance (6/3/2019)	Attendance (7/3/2019)
1	DEEPAK MALEKAR	Malekar	Malekar	Malekar	Malekar	Malekar	Malekar
2	PAWAN BIRADAR	Biradar	Biradar	Biradar	- AB -	- AB -	- AB -
3	AKSHAY PATIL	Patil	Patil	Patil	A.B	- AB -	Patil
4	UTKARSH NEB	- AB -	- AB -	Uneb	Uneb	Uneb	Uneb
5	VIJAY JADHAV	V.jadhav	- AB -	- AB -	V.jadhav	V.jadhav	V.jadhav
6	RAHULSINGH JADOUN	R.jadoun	R.jadoun	R.jadoun	- AB -	R.jadoun	- AB -
7	SIDDESH GIRI	Siddesh	Siddesh	Siddesh	Siddesh	- AB -	- AB -
8	BHUSHAN MOHITE	Bhushan	Bhushan	Bhushan	Bhushan	Bhushan	Bhushan
9	SUJAY JAGDALE	S.jagdale	S.jagdale	S.jagdale	S.jagdale	S.jagdale	S.jagdale
10	INDRAJIT NIKAM	Indrajit	Indrajit	Indrajit	Indrajit	Indrajit	Indrajit
11	NARESH ANANTWAR	Nanesh	Nanesh	- AB -	- AB -	Nanesh	- AB -
12	ISHWAR DYADE	Ishwar	Ishwar	Ishwar	Ishwar	Ishwar	- AB -
13	MADHUR DEOOLKAR	M.deolkar	M.deolkar	M.deolkar	M.deolkar	- AB -	M.deolkar
14	ASHISH KAITAKE	Ashish	Ashish	Ashish	Ashish	Ashish	Ashish
15	MAYUR PAWAR	Mayur	Mayur	Mayur	Mayur	Mayur	Mayur
16	NISHANT PAWAR	Nishant	Nishant	- AB -	- AB -	Nishant	Nishant
17	ANAND ASWA	A.V. Aswani	A.V. Aswani	A.V. Aswani	A.V. Aswani	A.V. Aswani	A.V. Aswani
18	DEEPAK SAVALE	Deepak	Deepak	Deepak	Deepak	Deepak	Deepak

Sushilkumar Bhagat
 Prop. S.S. Yadav.

Sushilkumar Bhagat
 Head of the Department,
MECHANICAL ENGINEERING
 Genba Sopanrao Moze College of Engg
 25/1/3, Balewadi, Pune-411045.



Genba Sopanrao Moze Trust's
GENBA SOPANRAO MOZE COLLEGE OF ENGINEERING

Balewadi, Pune-411045

Department of Mechanical Engineering

Academic Year-2018-19

Softskill (CATIA) Training by Mr. Sushilkumar Bhagat (G2G Innovation)

2	PAWAN BIRADAR	Biradar	Biradar	Biradar	Biradar	Biradar	Biradar
3	AKSHAY PATIL	AB-	AKSHAY	AKSHAY	AB-	AKSHAY	AKSHAY
4	UTKARSH NEB	UNeb	UNeb	AB-	UNeb	UNeb	UNeb
5	VIJAY JADHAV	V.Jadhav	V.Jadhav	AB-	AB-	V.Jadhav	AB-
6	RAHUL SINGH JADOUN	R.Jadoun	AB-	AB-	AB-	R.Jadoun	R.Jadoun
7	SIDDESH GIRI	Siddesh	Siddesh	Siddesh	AB-	Siddesh	Siddesh
8	BIHUSHAN MOHITE	Bihushan	Bihushan	Bihushan	Bihushan	Bihushan	Bihushan
9	SUJAY JAGDALE	Jagdale	Jagdale	Jagdale	Jagdale	Jagdale	Jagdale
10	INDRAJIT NIKAM	Indrajit	Indrajit	Indrajit	Indrajit	Indrajit	Indrajit
11	NARESH ANANTWAR	Naresh	Naresh	AB-	AB-	Naresh	Naresh
12	ISHWAR DYADE	Ishwar	Ishwar	AB-	AB-	Ishwar	Ishwar
13	MADHUR DEOOLKAR	Madur	Madur	Madur	Madur	Madur	Madur
14	ASHISH KAITAKE	Ashish	Ashish	Ashish	Ashish	Ashish	Ashish
15	MAYUR PAWAR	Mayur	Mayur	Mayur	Mayur	Mayur	Mayur
16	NISHANT PAWAR	AB-	Nishant	Nishant	AB-	Nishant	Nishant
17	ANAND ASWA	A.V. Aswa	A.V. Aswa	A.V. Aswa	A.V. Aswa	A.V. Aswa	A.V. Aswa
18	DEEPAK SAVALE	Deepak	Deepak	Deepak	Deepak	Deepak	Deepak
	Deepak Malekar	Malekar	Malekar	Malekar	Malekar	Malekar	Malekar
		08/08/19	09/08/19	11/08/19	12/08/19	13/08/19	14/08/19

Prof. S. Yadav

Sat



Genba Sopanrao Moze Trust's
GENBA SOPANRAO MOZE COLLEGE OF ENGINEERING
 Balewadi, Pune-411045
 Department of Mechanical Engineering
 Academic Year-2018-19

Softskill (CATIA) Training by Mr. Sushilkumar Bhagat (G2G Innovation)

2	PAWAN BIRADAR	<u>Biradar</u>	<u>Biradar</u>	-AB-	-AB-	AB-	-AB-
3	AKSHAY PATIL	-A.D.	Patil	Patil	Patil	Patil	Patil
4	UTKARSH NEB	<u>UNeb</u>	-AB-	<u>UNeb</u>	<u>UNeb</u>	<u>UNeb</u>	<u>UNeb</u>
5	VIJAY JADHAV	-A.B-	<u>V.Jadhav</u>	<u>V.Jadhav</u>	-A.B-	<u>V.Jadhav</u>	-A.D.
6	RAHULSINGH JADOUN	<u>Rjadoun</u>	<u>Rjadoun</u>	AB-	-AB-	<u>Rjadoun</u>	<u>Rjadoun</u>
7	SIDDESH GIRI	<u>Siddesh</u>	-AB-	<u>Siddesh</u>	<u>Siddesh</u>	<u>Siddesh</u>	<u>Siddesh</u>
8	BHUSHAN MOHITE	Mohite	Mohite	Mohite	Mohite	Mohite	Mohite
9	SUJAY JAGDALE	<u>Jagdale</u>	<u>Jagdale</u>	<u>Jagdale</u>	<u>Jagdale</u>	<u>Jagdale</u>	<u>Jagdale</u>
10	INDRAJIT NIKAM	<u>Indrajit</u>	<u>Indrajit</u>	<u>Indrajit</u>	<u>Indrajit</u>	<u>Indrajit</u>	<u>Indrajit</u>
11	NARESH ANANTWAR	<u>Nan</u>	<u>Nan</u>	<u>Nan</u>	-A.B-	-A.B-	<u>Nan</u>
12	ISHWAR DYADE	<u>Is</u>	<u>Is</u>	<u>Is</u>	<u>Is</u>	<u>Is</u>	<u>Is</u>
13	MADHUR DEOLKAR	-A.D-	-A.B-	-A.B-	-A.B-	-A.B-	-A.B-
14	ASHISH KAITAKE	-A.B-	<u>Ashish</u>	<u>Ashish</u>	<u>Ashish</u>	<u>Ashish</u>	<u>Ashish</u>
15	MAYUR PAWAR	<u>Mayur</u>	<u>Mayur</u>	<u>Mayur</u>	<u>Mayur</u>	<u>Mayur</u>	<u>Mayur</u>
16	NISHANT PAWAR	<u>Nishant</u>	<u>Nishant</u>	<u>Nishant</u>	<u>Nishant</u>	-A.B-	<u>Nishant</u>
17	ANAND ASWA	<u>A.V.Aswa</u>	<u>A.V.Aswa</u>	<u>A.V.Aswa</u>	<u>A.V.Aswa</u>	<u>A.V.Aswa</u>	<u>A.V.Aswa</u>
18	DEEPAK SAVALE	<u>Des</u>	<u>Des</u>	AB-	AB-	<u>Des</u>	<u>Des</u>
-	Deepak Malekar	Malekar	Malekar	Malekar	Malekar	Malekar	Malekar
		15/03/19	16/03/19	18/03/19	19/03/19	20/03/19	21/03/19

Prof. S.S. Jadhav

Head of the Department,
MECHANICAL ENGINEERING
 Genba Sopanrao Moze College of Eng.
 25/1/3, Balewadi, Pune-411045

Genba Sopanrao Moze Trust's
GENBA SOPANRAO MOZE COLLEGE OF ENGINEERING
 Balewadi, Pune-411045
 Department of Mechanical Engineering
 Academic Year-2018-19

Softskill (CATIA) Training by Mr. Sushilkumar Bhagat (G2G Innovation)

2	PAWAN BIRADAR	Biradar	Biradar	Biradar	Biradar	Biradar	Biradar
3	AKSHAY PATHI	Pathi	Pathi	Pathi	Pathi	Pathi	Pathi
4	UTKARSH NEB	UNeb	AB-	UNeb	UNeb	UNeb	UNeb
5	VUAY JADHAV	V.Jadhav	V.Jadhav	V.Jadhav	V.Jadhav	V.Jadhav	V.Jadhav
6	RAHULSINGH JADOUN	-AB-	Rajadon	Rajadon	-AB-	Rajadon	Rajadon
7	SIDDESH GIRI	-AB-	-AB-	-AB-	Siddesh	Siddesh	-AB-
8	BHUSHAN MOHITE	Mohite	Mohite	Mohite	Mohite	Mohite	Mohite
9	SUJAY JAGDALE	Jagdale	Jagdale	Jagdale	Jagdale	Jagdale	Jagdale
10	INDRAJIT NIKAM	Indrajit	Indrajit	Indrajit	Indrajit	Indrajit	Indrajit
11	NARESH ANANTWAR	Nar	Anre	-AB-	-AB-	-AB-	-AB-
12	ISHWAR DYADE	Dyade	Dyade	Dyade	-AB-	Dyade	Dyade
13	MADHUR DEGOLKAR	-AB-	-AB-	-AB-	-AB-	-AB-	-AB-
14	ASHISH KATTAKE	Kattake	Kattake	Kattake	Kattake	AB	Kattake
15	MAYUR PAWAR	Pawar	Pawar	Pawar	Pawar	Pawar	Pawar
16	NIBHANT PAWAR	Nibant	Nibant	Nibant	Nibant	Nibant	Nibant
17	ANANDASWA	A.v Anand	A.v Anand	A.v Anand	A.v Anand	A.v Anand	A.v Anand
18	DEEPAK SAVALE	Savale	Savale	Savale	Savale	AB-	Savale
	Deepak Mulekar	Mulekar	Mulekar	Mulekar	Mulekar	Mulekar	Mulekar
		22/03/19	23/03/19	25/03/19	26/03/19	27/03/19	29/03/19

M.S.S. Jadhav



Head of the Department,
MECHANICAL ENGINEERING
 Genba Sopanrao Moze
 25/1/3, Balewadi, Pune-411045

SOPANRAO MOZE TRUST'S, PUNE

GENBA SOPANRAO MOZE COLLEGE OF ENGINEERING

BALEWADI, PUNE-45



This is to certify that Mr./Ms./ Aakash Sutar has participate in an Add-on Course on "Softskill Training on HyperMesh" conducted by Department of Mechanical Engineering , GSMCOE, Balewadi, Pune held between 03 Septmber 2018 to 04 October 2018.

Course Coordinator

Prof. S. S. Yadav

Head of Department

Prof. Dr. V Jaiganesh

Principal

Prof. Dr. A. B. Auti



SOPANRAO MOZE TRUST'S, PUNE

GENBA SOPANRAO MOZE COLLEGE OF ENGINEERING

BALEWADI, PUNE-45



This is to certify that Mr./Ms./ Anil Ingle has participate in an Add-on Course on "Softskill Training on HyperMesh" conducted by Department of Mechanical Engineering , GSMCOE, Balewadi, Pune held between 03 September 2018 to 04 October 2018.



Course Coordinator

Prof. S. S. Yadav

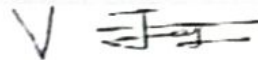

Head of Department

Prof. Dr. V Jaiganesh



Principal

Prof. Dr. A. B. Auti



SOPANRAO MOZE TRUST'S, PUNE

GENBA SOPANRAO MOZE COLLEGE OF ENGINEERING

BALEWADI, PUNE-45



This is to certify that Mr./Ms./ Amir Ansari has participate in an Add-on Course on "Softskill Training on HyperMesh" conducted by Department of Mechanical Engineering, GSMCOE, Balewadi, Pune held between 03 September 2018 to 04 October 2018.

Course Coordinator

Prof. S. S. Yadav

Head of Department

Prof. Dr. V Jaiganesh

Principal

Prof. Dr. A. B. Auti



SOPANRAO MOZE TRUST'S, PUNE

GENBA SOPANRAO MOZE COLLEGE OF ENGINEERING

BALEWADI, PUNE-45



This is to certify that Mr./Ms./ Sandesh Navale has participate in an Add-on Course on "Softskill Training on HyperMesh" conducted by Department of Mechanical Engineering , GSMCOE, Balewadi, Pune held between 03 September 2018 to 04 October 2018.

Course Coordinator

Prof. S. S. Yadav

Head of Department

Prof. Dr. V Jaiganesh

Principal

Prof. Dr. A. B. Auti



GENBA SOPANRAO MOZE TRUST'S, PUNE

GENBA SOPANRAO MOZE COLLEGE OF ENGINEERING

BALEWADI, PUNE-45



This is to certify that Mr./Ms./ Sayyad Asif has participate in an Add-on Course on "Softskill Training on HyperMesh" conducted by Department of Mechanical Engineering, GSMCOE, Balewadi, Pune held between 03 September 2018 to 04 October 2018.

Course Coordinator

Prof. S. S. Yadav

Head of Department

Prof. Dr. V Jaiganesh

Principal

Prof. Dr. A. B. Auti



SOPANRAO MOZE TRUST'S, PUNE

GENBA SOPANRAO MOZE COLLEGE OF ENGINEERING

BALEWADI, PUNE-45



This is to certify that Mr./Ms./ Siddesh Giri has participate in an Add-on Course on "Softskill Training on CATIA" conducted by Department of Mechanical Engineering , GSMCOE, Balewadi, Pune held between 01 March 2019 to 30 March 2019.

Course Coordinator

Prof. S. S. Yadav

Head of Department

Prof. Dr. V Jaiganesh

Principal

Prof. Dr. A. B. Auti



SOPANRAO MOZE TRUST'S, PUNE

GENBA SOPANRAO MOZE COLLEGE OF ENGINEERING

BALEWADI, PUNE-45



This is to certify that Mr./Ms./ Mayur Pawar has participate in an Add-on Course on "Softskill Training on CATIA" conducted by Department of Mechanical Engineering , GSMCOE, Balewadi, Pune field between 01 March 2019 to 30 March 2019.

Course Coordinator

Prof. S. S. Yadav

Head of Department

Prof. Dr. V Jaiganesh

Principal

Prof. Dr. A. B. Auti



SOPANRAO MOZE TRUST'S, PUNE

GENBA SOPANRAO MOZE COLLEGE OF ENGINEERING

BALEWADI, PUNE-45



This is to certify that Mr./Ms./ Nishant Pawar has participate in an Add-on Course on "Softskill Training on CATIA" conducted by Department of Mechanical Engineering , GSMCOE, Balewadi, Pune held between 01 March 2019 to 30 March 2019.

Course Coordinator

Prof. S. S. Yadav

Head of Department

Prof. Dr. V Jaiganesh

Principal

Prof. Dr. A. B. Auti



GENBA SOPANRAO MOZE TRUST'S, PUNE

GENBA SOPANRAO MOZE COLLEGE OF ENGINEERING

BALEWADI, PUNE-45



This is to certify that Mr./Ms./ Deepak Malekar has participate in an Add-on Course on "Softskill Training on CATIA" conducted by Department of Mechanical Engineering , GSMCOE, Balewadi, Pune held between 01 March 2019 to 30 March 2019.

Course Coordinator

Prof. S. S. Yadav

Head of Department

Prof. Dr. V Jaiganesh

Principal

Prof. Dr. A. B. Auti



SOPANRAO MOZE TRUST'S, PUNE

GENBA SOPANRAO MOZE COLLEGE OF ENGINEERING

BALEWADI, PUNE-45



This is to certify that Mr./Ms./ Akshay Patil has participate in an Add-on Course on "Softskill Training on CATIA" conducted by Department of Mechanical Engineering , GSMCOE, Balewadi, Pune held between 01 March 2019 to 30 March 2019.

Course Coordinator

Prof. S. S. Yadav

Head of Department

Prof. Dr. V Jaiganesh

Principal

Prof. Dr. A. B. Auti





“EMPOWERMENT THROUGH TECHNOLOGICAL EXCELLENCE”
GENBA SOPANRAO MOZE COLLEGE OF ENGINEERING

S. No. 25/1/3, Balewadi, Pune – 411 045

(Approved by AICTE and Govt. of Maharashtra, Affiliated to Savitribai Phule Pune University)

DTE Code - EN6144 University Affiliation ID - PU/PN/ENGG/138/1999

Ph: 020-27390500

Website: www.gsmozecoe.org

Email: gsmoze@yahoo.co.in

Founder President: Shri Rambhau Moze

Department of Electronics & Telecommunication

Online Course Attendance Sheet

Course: JAVA

A.Y. 2018-19

Sr. No.	Student Name	22/1/19	2/2/19	9/2/19	16/2/19	21/2/19
1	Bhogan Amol Vaiju	<i>Amol</i>	<i>Amol</i>	<i>Amol</i>	<i>Amol</i>	<i>Amol</i>
2	Desai Dhairyshil Shripatrao	<i>Desai</i>	<i>Desai</i>	<i>Desai</i>	<i>Desai</i>	<i>Desai</i>
3	Gavali Archana Narayan	<i>Archana</i>	<i>Archana</i>	<i>Archana</i>	<i>Archana</i>	<i>Archana</i>
4	Ingale Shubham Santosh	<i>Shubham</i>	<i>Shubham</i>	<i>Shubham</i>	<i>Shubham</i>	<i>Shubham</i>
5	Jadhav Amit Ramesh	<i>Amit</i>	<i>Amit</i>	<i>Amit</i>	<i>Amit</i>	<i>Amit</i>
6	Jadhav Sneha Suresh Rao	<i>Sneha</i>	<i>Sneha</i>	<i>Sneha</i>	<i>Sneha</i>	<i>Sneha</i>
7	Singh Shikha Sunil	<i>Shikha</i>	<i>Shikha</i>	<i>Shikha</i>	<i>Shikha</i>	<i>Shikha</i>
8	Metry Vidyavati Vijayakumar	<i>V. metry</i>	<i>V. metry</i>	<i>V. metry</i>	<i>V. metry</i>	<i>V. metry</i>
9	Munde Sushma Balasaheb	<i>Sushma</i>	<i>Sushma</i>	<i>Sushma</i>	<i>Sushma</i>	<i>Sushma</i>
10	Boynale Manisha P	<i>Manisha</i>	<i>Manisha</i>	<i>Manisha</i>	<i>Manisha</i>	<i>Manisha</i>

Jayashri K.
Prof. Prof. Jayashri K.
Co-ordinator

Punam C.
Prof. Punam C.
HOD(E&TC)
Electronic & Telecommunication Engg.
Genba Sopanrao Moze College of Engg.
Balewadi, Pune - 411 045.

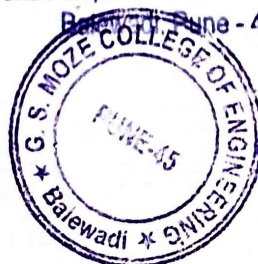

A. B. Auti
Dr. A. B. Auti
Principal
PRINCIPAL
Genba Sopanrao Moze College of Engg.
25/1/3, Balewadi, Pune - 411 045

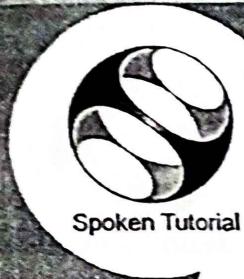

Spoken Tutorial

Certificate for Completion of Java Training



Talk To A Teacher

This is to certify that **Amol V. Bhogan** has successfully completed **Java** test organized at **Genba Sopanrao Moze College of Engineering** by **Shital Kolte** with course material provided by the **Talk To A Teacher** project at **IIT Bombay**.

Passing an online exam, conducted remotely from **IIT Bombay**, is a pre-requisite for completing this training. **SNEHA FARKADE** at **Genba Sopanrao Moze College of Engineering** invigilated this examination. This training is offered by the **Spoken Tutorial Project, IIT Bombay, funded by National Mission on Education through ICT, MHRD, Govt., of India**.

February 22nd 2019

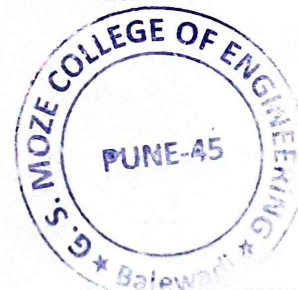

Kannan M Moudgalya
Prof. Kannan M Moudgalya
IIT Bombay



Spoken Tutorial

Certificate for Completion of Java Training



Talk To A Teacher

This is to certify that **Amit Jadhav** has successfully completed **Java** test organized at **Genba Sopanrao Moze College of Engineering** by **Shital Kolte** with course material provided by the Talk To A Teacher project at IIT Bombay.

Passing an online exam, conducted remotely from IIT Bombay, is a pre-requisite for completing this training. **SNEHA FARKADE** at **Genba Sopanrao Moze College of Engineering** invigilated this examination. This training is offered by the **Spoken Tutorial Project, IIT Bombay, funded by National Mission on Education through ICT, MHRD, Govt., of India.**

February 22nd 2019

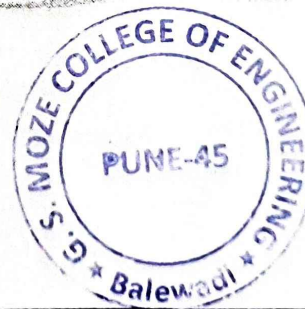

A handwritten signature in black ink, appearing to read 'Kannan Moudgalya'.

Prof. Kannan M Moudgalya
IIT Bombay



Spoken Tutorial

Certificate for Completion of Java Training



Talk To A Teacher

This is to certify that Dhairyshil Desai has successfully completed Java test organized at Genba Sopanrao Moze College of Engineering by Shital Kolte with course material provided by the Talk To A Teacher project at IIT Bombay.

Passing an online exam, conducted remotely from IIT Bombay, is a pre-requisite for completing this training. SNEHA FARKADE at Genba Sopanrao Moze College of Engineering invigilated this examination. This training is offered by the Spoken Tutorial Project, IIT Bombay, funded by National Mission on Education through ICT, MHRD, Govt., of India.

February 22nd 2019

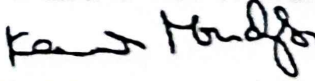

Prof. Kannan M Moudgalya
IIT Bombay



Certificate for Completion of Java Training



Talk To A Teacher

This is to certify that **Archana Gavali** has successfully completed **Java test** organized at **Genba Sopanrao Moze College of Engineering** by **Shital Kolte** with course material provided by the **Talk To A Teacher** project at **IIT Bombay**.

Passing an online exam, conducted remotely from **IIT Bombay**, is a pre-requisite for completing this training. **SNEHA FARKADE** at **Genba Sopanrao Moze College of Engineering** invigilated this examination. This training is offered by the **Spoken Tutorial Project, IIT Bombay**, funded by **National Mission on Education through ICT, MHRD, Govt., of India**.

February 22nd 2019

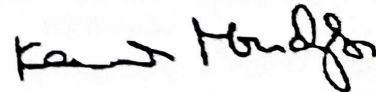

Prof. Kannan M Moudgalya
IIT Bombay



Spoken Tutorial

Certificate for Completion of Java Training



Talk To A Teacher

This is to certify that **Shubham Ingale** has successfully completed **Java** test organized at **Genba Sopanrao Moze College of Engineering** by **Shital Kolte** with course material provided by the Talk To A Teacher project at IIT Bombay.

Passing an online exam, conducted remotely from IIT Bombay, is a pre-requisite for completing this training. **SNEHA FARKADE** at **Genba Sopanrao Moze College of Engineering** invigilated this examination. This training is offered by the **Spoken Tutorial Project, IIT Bombay, funded by National Mission on Education through ICT, MHRD, Govt., of India.**

February 22nd 2019

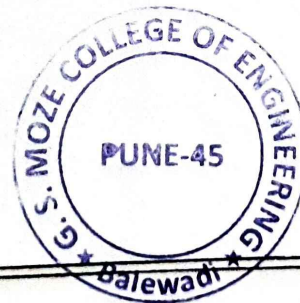

Kannan M Moudgalya
Prof. Kannan M Moudgalya
IIT Bombay